

4-Channel Wi-Fi Relay Module

General Description

The RM4W is a 4-channel Wi-Fi module based on the ESP-12F module which is based on the ESP8266 chip from Espressif. The ESP-12F includes 4MB of flash and supports 802.11b/g/n Wi-Fi SOC. The ESP-12F can be programmed serially via the 4-pin header. The card is well-protected, filtered, and easy to install. The RM4W outputs can drive loads up to 10A (resistive load).

Features

- Based on ESP-12F Wi-Fi module.
- On-board 3.3V regulator AMS1117-3.3V.
- Power input is filtered for noise reduction.
- Green LED for power indication.
- Operating voltage DC12V.
- Four output relays with red LED indicators.
- Both normal open and normal close terminals are available.
- Output terminals are available through 5mm 2-pin K128 screw clamp.
- Easy firmware uploading using 4-pin header (3.3V, Tx, Rx, GND).
- Reset push button switch is included.
- Two yellow LEDs for Tx and Rx signal indication.
- DIN Rail mountable.
- Four mounting holes for easy installation.



Board Details

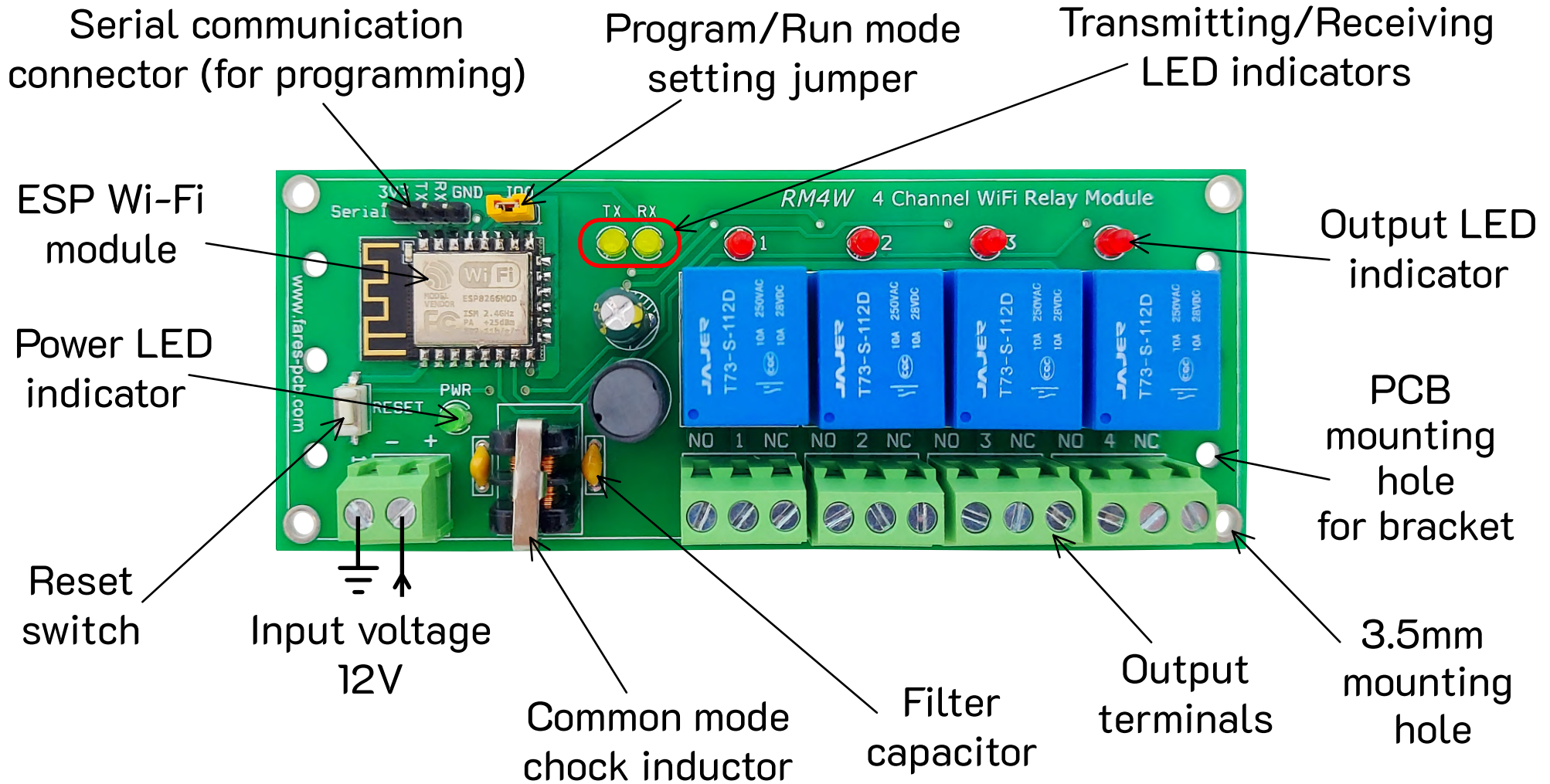

DIN Rail Mounting Options

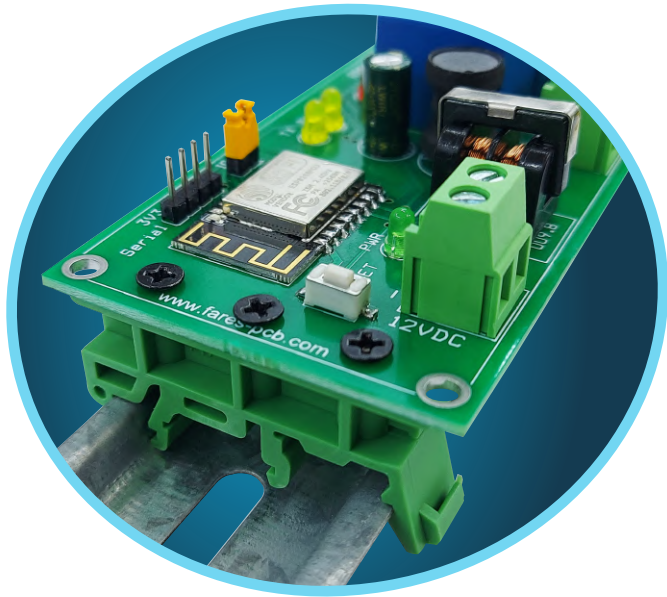

PCB Bracket



PCB Carrier

How to Program ?

To upload your code on (ESP) module, some hardware and software tools should be available.

Hardware requirements

- PC (personal computer), laptop or smart phone.
- USB/Serial converter.
- USB cable.

Software requirements

- Arduino IDE Tool.

Hardware preparing (programming mode)

1-Connect USB/Serial converter to PC.

2-Connect USB/Serial converter to RM4W module as shows below.



a-Connect GND (RM4W) to GND (USB/Serial converter).

b-Connect 3V3 (RM4W) to 3V3 (USB/Serial converter).

c-Connect RX (RM4W) to TX (USB/Serial converter).

d-Connect TX(RM4W) to RX (USB/Serial converter).

3-Connect I00 jumper (programming module).

4-Press **RESET** switch to initiate programming mode.

Upload your code

1-Download and install Arduino IED from the following link

<https://www.arduino.cc/en/software>

2-Open your Arduino .ino file.

3-GO to File > Preferences and copy the link below to boards manager URLs.

http://arduino.esp8266.com/stable/package_esp8266com_index.json

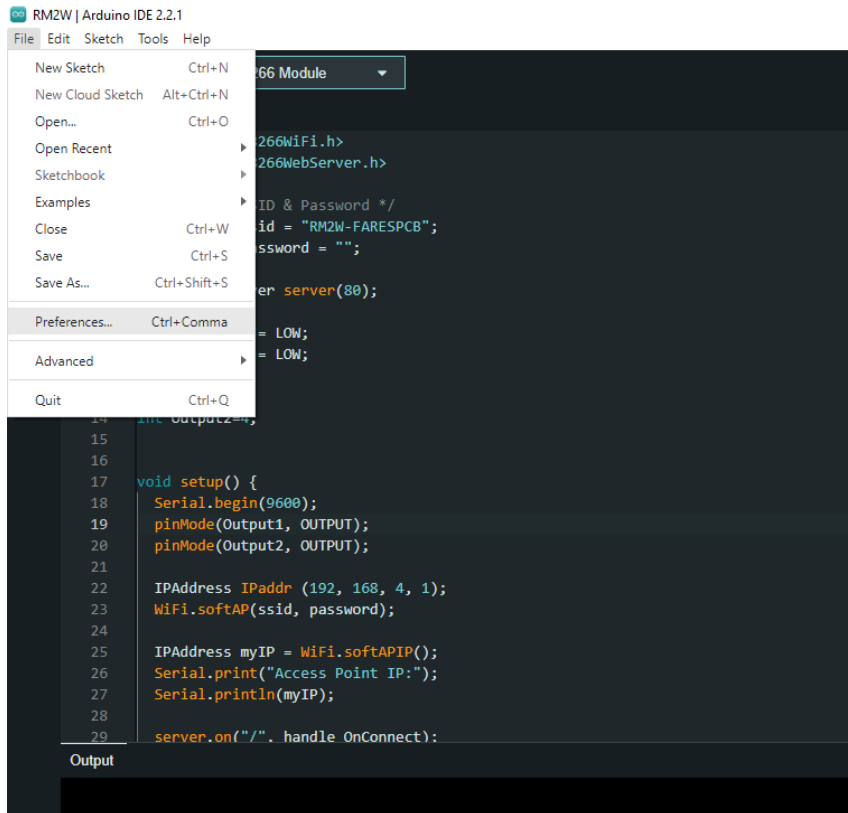

```
RM2W | Arduino IDE 2.2.1
File Edit Sketch Tools Help
New Sketch Ctrl+N
New Cloud Sketch Alt+Ctrl+N
Open... Ctrl+O
Open Recent
Sketchbook
Examples
Close Ctrl+W
Save Ctrl+S
Save As... Ctrl+Shift+S
Preferences... Ctrl+Comma
Advanced
Quit Ctrl+Q

66 Module
266WiFi.h>
266WebServer.h>
ID & Password */
id = "RM2W-FARESPCB";
ssword = "";
er server(80);
= LOW;
= LOW;

14
15
16
17 void setup() {
18   Serial.begin(9600);
19   pinMode(Output1, OUTPUT);
20   pinMode(Output2, OUTPUT);
21
22   IPAddress IPaddr (192, 168, 4, 1);
23   WiFi.softAP(ssid, password);
24
25   IPAddress myIP = WiFi.softAPIP();
26   Serial.print("Access Point IP:");
27   Serial.println(myIP);
28
29   server.on("/". handle OnConnect);

Output
```

4-Click OK.

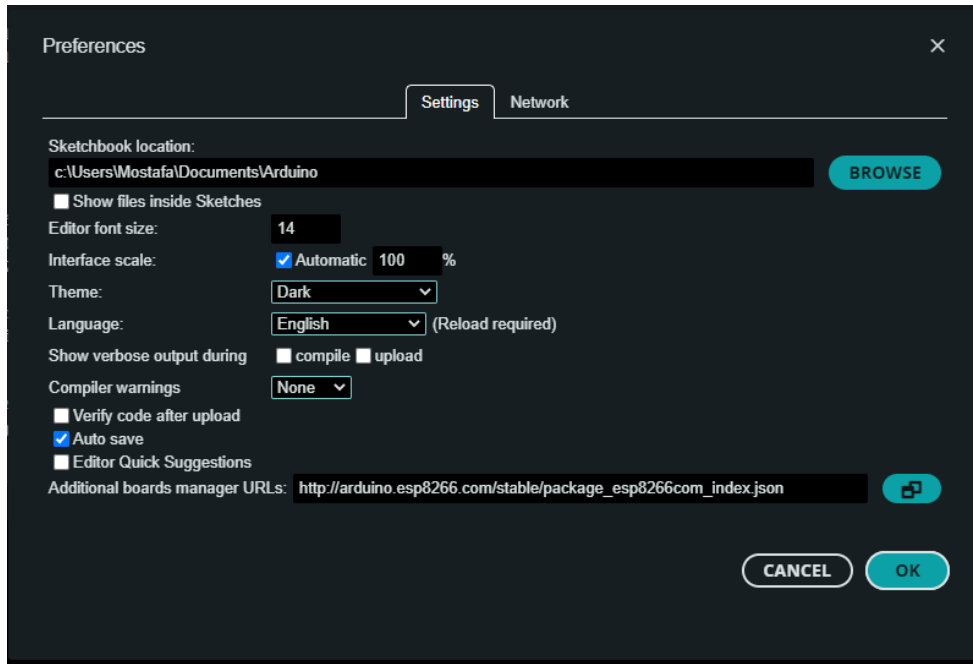

5-Go to Tools> Board> Board Manager.

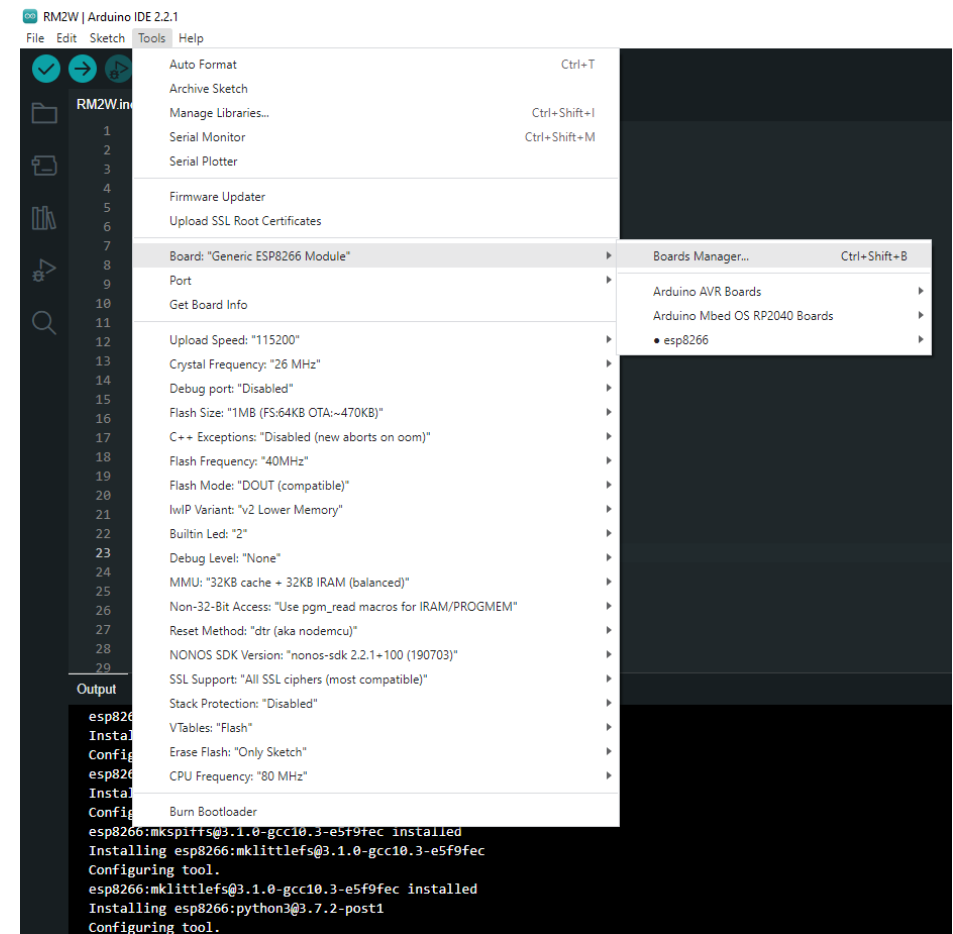

6-Type esp8266 and click INSTALL.

RM2W | Arduino IDE 2.2.1

File Edit Sketch Tools Help

The screenshot shows the Arduino IDE interface. In the 'BOARDS MANAGER' on the left, 'esp8266' is entered in the search box, and 'All' is selected in the 'Type' dropdown. The 'esp8266' board by the 'ESP8266 Community' is listed, with version '3.1.2' and an 'INSTALL' button highlighted. The main editor shows the 'RM2W.ino' file with the following code:

```
1 #include <ESP8266WiFi.h>
2 #include <ESP8266WebServer.h>
3
4 /* Put your SSID & Password */
5 const char* ssid = "RM2W-FARESPCB";
6 const char* password = "";
7
8 ESP8266WebServer server(80);
9
10 bool O1Status = LOW;
11 bool O2Status = LOW;
12
13 int Output1=5;
14 int Output2=4;
15
16
17 void setup() {
18   Serial.begin(9600);
19   pinMode(Output1, OUTPUT);
20   pinMode(Output2, OUTPUT);
21
22   IPAddress IPaddr (192, 168, 4, 1);
23   WiFi.softAP(ssid, password);
24
25   IPAddress myIP = WiFi.softAPIP();
26   Serial.print("Access Point IP:");
27   Serial.println(myIP);
28
29   server.on("/".handle OnConnect):
```

At the bottom, the 'Output' window shows: 'Uninstalling esp8266:esp8266@3.1.2' and 'Platform esp8266:esp8266@3.1.2 uninstalled'.

7- Go to Tools > Board > esp8266 > Generic ESP8266 Module.

RM2W | Arduino IDE 2.2.1

File Edit Sketch Tools Help

The screenshot shows the Arduino IDE interface with the 'Tools' menu open. The path 'Tools > Board > esp8266 > Generic ESP8266 Module' is highlighted. The 'Generic ESP8266 Module' is selected in the 'Boards Manager' on the right. The main editor shows the 'RM2W.ino' file with the following code:

```
.h>
server.h>
password */
RM2W-FARESPCB";
= "";
```

The 'Output' window shows the following messages:

```
esp8266:mkspi11sg3.1.0-gcc10.3-e5f9fec installed
Installing esp8266:mk1littlefs@3.1.0-gcc10.3-e5f9fec
Configuring tool.
esp8266:mk1littlefs@3.1.0-gcc10.3-e5f9fec installed
Installing esp8266:python3@3.7.2-post1
Configuring tool.
esp8266:python3@3.7.2-post1 installed
Installing platform esp8266:esp8266@3.1.2
Configuring platform.
Platform esp8266:esp8266@3.1.2 installed
```

8- Go to Tools > Port > COM.

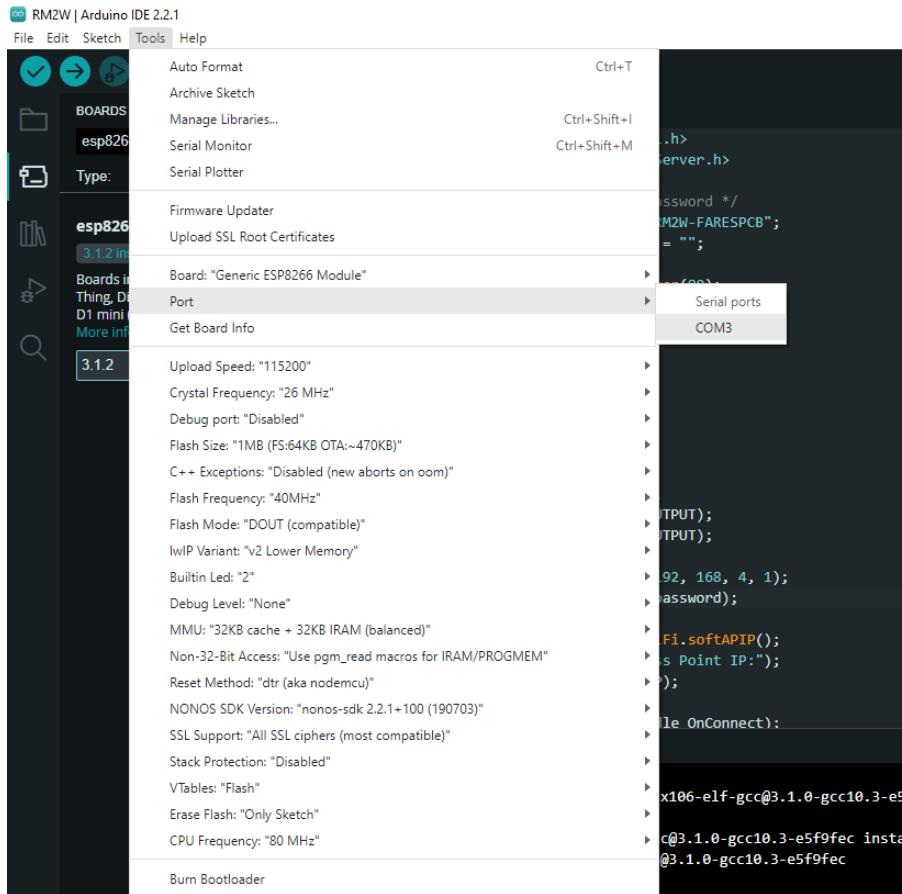

9-Click Upload icon to compile and upload your code.

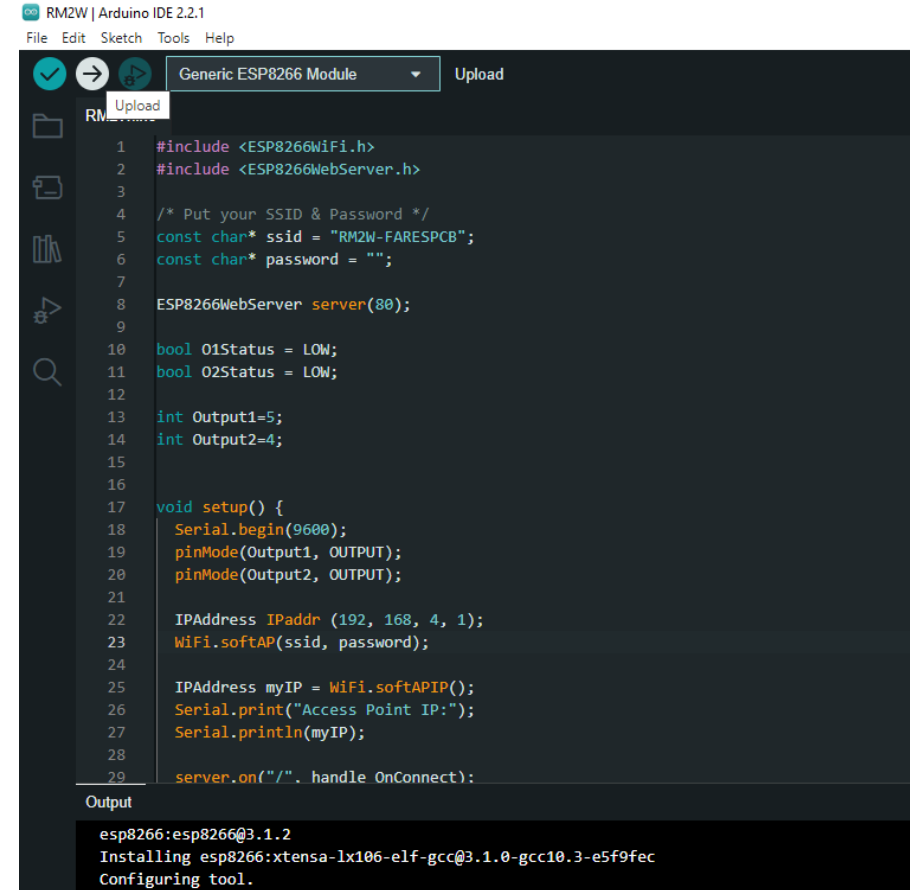

How to test ?

RM4W module comes pre-programmed with a test code that can be used to apply control via any browser page.

The code is available at this link: <https://fares-pcb.com/product/4-channel-wireless-relay-module-esp-12f-rm4w/>

Test Steps

1-Ensure the I00 jumper is removed.

2-Connect power supply 12V.

3-A Wi-Fi network signal will popup denoted by (RM4W-FARESPCB).

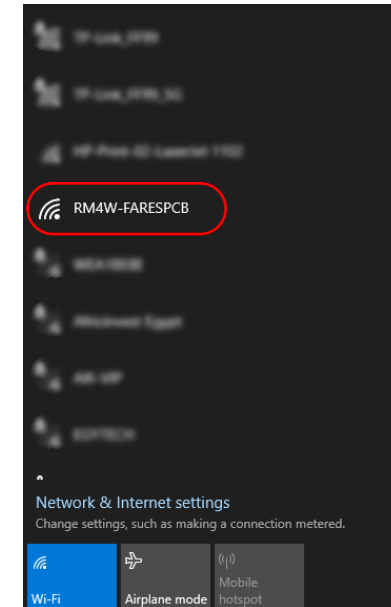
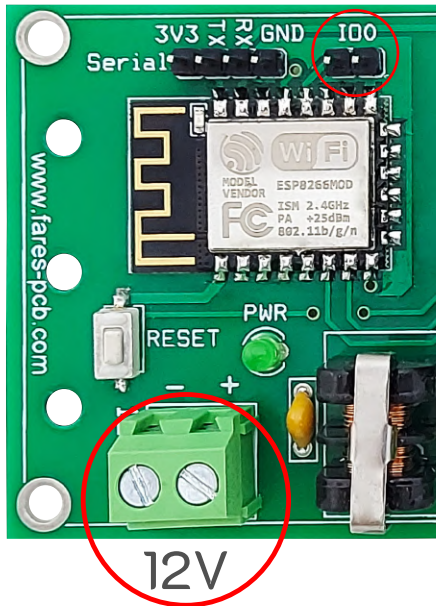

4- Connect using PC or Smart phone.

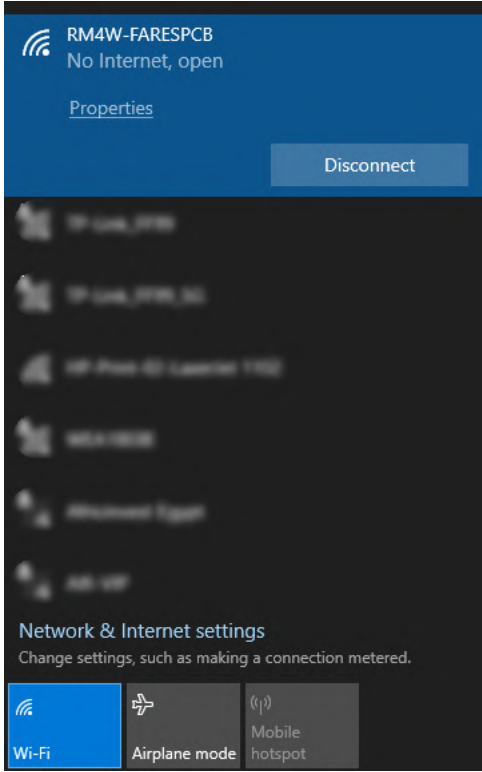

5-Open any web browser and input the default IP address “ 192.168.4.1 ”.

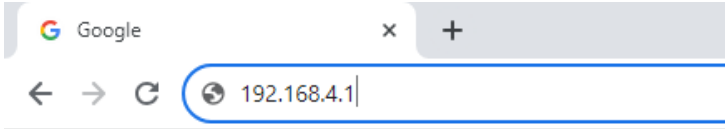

6-Control page will be loaded. Use **ON/OFF** buttons to control output relays.

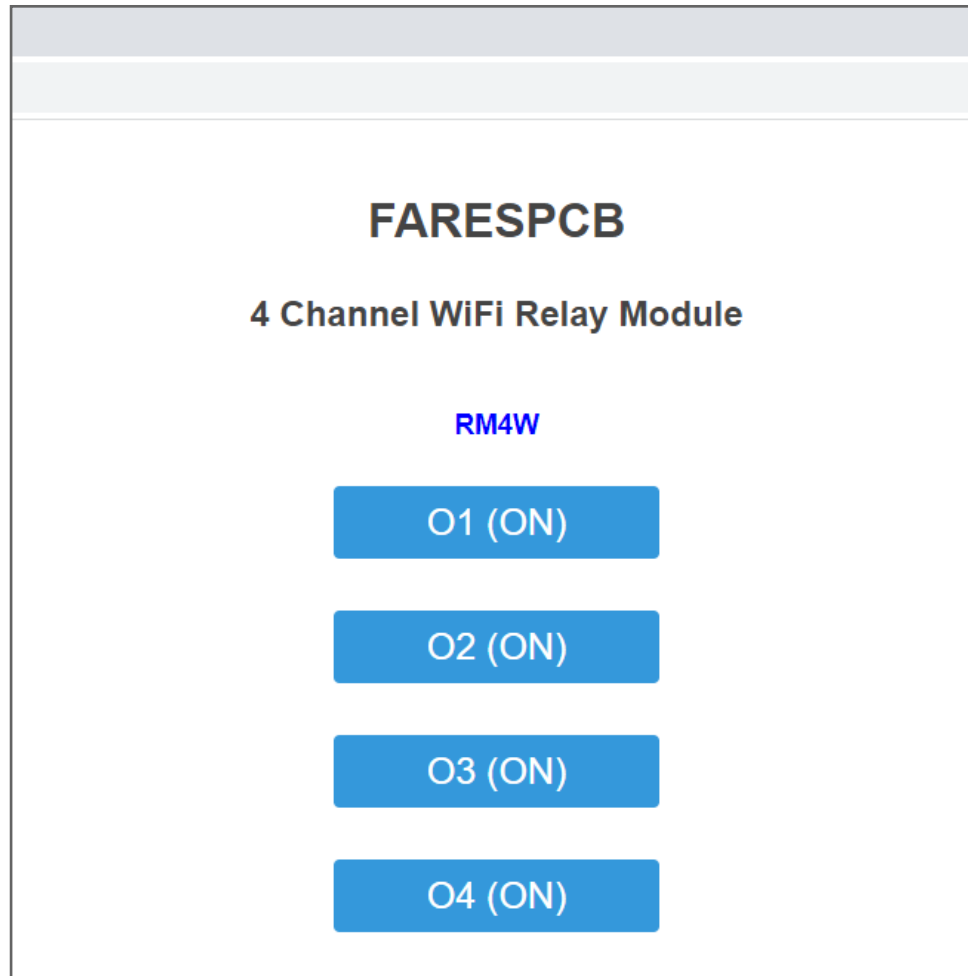

Output relays are routed to ESP-12F GPIOs as shown in the table below

Output Relay	ESP-12F GPIO pin
Relay 1	GPIO5
Relay 2	GPIO4
Relay 3	GPIO13
Relay 4	GPIO12

Mechanical Dimensions Diagram

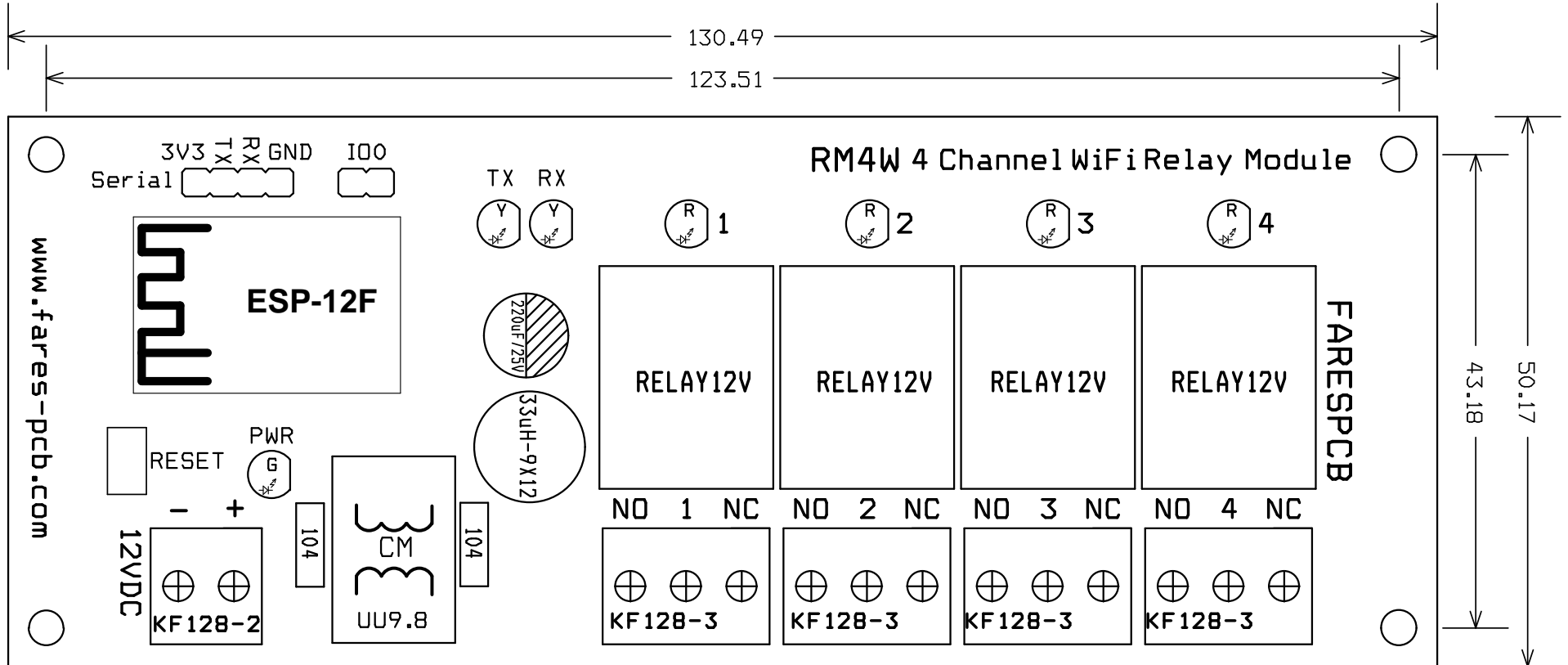

All dimensions are in mm

For our full range of products, see our website at <http://www.fares-pcb.com>

If you have any technical questions about our products,
e-mail us at www.support@fares-pcb.com

FARES^{PCB} co. (Head office)

32 El-Falaky st, Bab El-Louq, Tahrir, Cairo, Egypt.

Tel: +202-27901841

Mob: +201022457902

FARES^{PCB} Co reserves the right to make changes in circuit design, software and/or specifications at any time without prior notice. For the latest updated information, please visit our website at <http://www.fares-pcb.com>.

Information furnished by is believed to be accurate and reliable. However, **FARES^{PCB}** assumes no responsibility arising from the use of the specifications described.

Distributor:

RAM Electronics

32 El Falaky St. Bab El Louk, Tahrir, Cairo, Egypt

Tel: +202-27960551

www.ram.com.eg

Sales@ram-electronics.com.

RAM[®] Electronics
INTEGRATED SOLUTIONS AT ONE PLACE